

**PRODUCT CODE: MP15**  
CHANNEL BRACKET

**DESCRIPTION**

90° Tee Bracket

**FINISH**

Hot Dipped Galvanised

**MATERIAL**

Steel

**PACKAGING**

Packed in qty 25

**ADDITIONAL NOTES**

Compliant to LU Standard 1-085 (for use on surface & sub-surface locations)

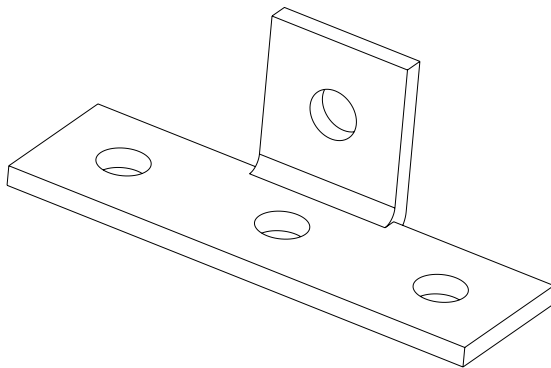
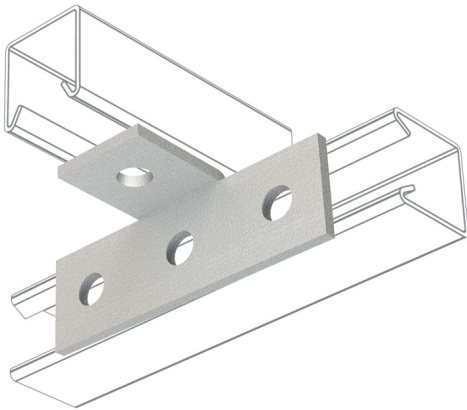

Isometric view

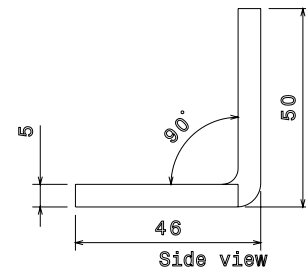

Side view

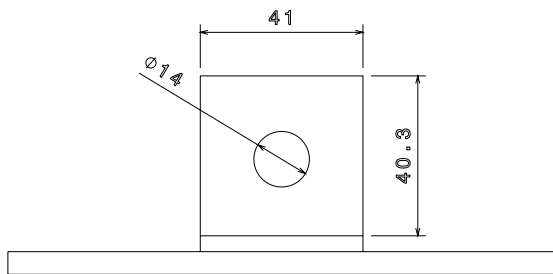

Front view

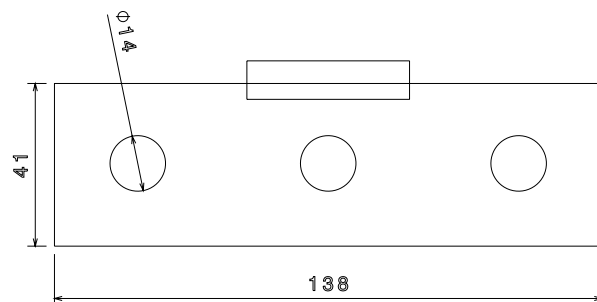

Top view